

Article number: 20194B42B422SW

Description: E+G

T-angel clamps GN194-B42-B42-2-SW

Measures

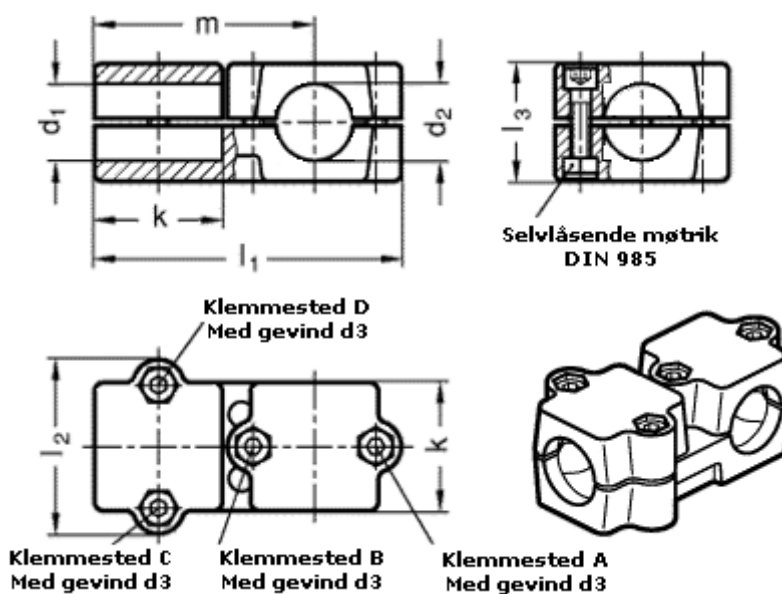

d1 = 42
d2 = 42
d3 = M10
k = 76
l1 = 176
l2 = 98
l3 = 70
m = 126